

Buss-SMS-Canzler



Process Engineering and Special Equipment Manufacturing

We live process engineering
and special manufacturing

SMS

Buss-SMS-Canzler

There is no limit to competence Buss-SMS-Canzler

2



Buss-SMS-Canzler is one of the world's leading suppliers of thermal separation technology for difficult to handle substances and mixtures.

We are the leading specialists in thin film technology. Our technical engineering solutions are based on decades of experiences of the Luwa, SMS, Buss and Canzler companies. As a modern and internationally active company, we develop and manufacture systems and equipment in the field of evaporation, drying, high-viscosity and membrane technology.

We also manufacture special equipment, for example made out of copper and copper alloys, and are active in the nuclear industry. Supported by a comprehensively equipped test centre with 20 pilot systems, our staff of more than 200 employees develops both individual and economical solutions for the process engineering requirements of our customers. Solutions, that renowned globally-active companies have trusted for many years - from the plastics, fibres, polymer, specialty chemicals, agro-chemicals, oleo- and petrochemicals, fine and basic chemicals and the food industries, to the pharmaceutical industry as well as companies working on environmental and energy issues.

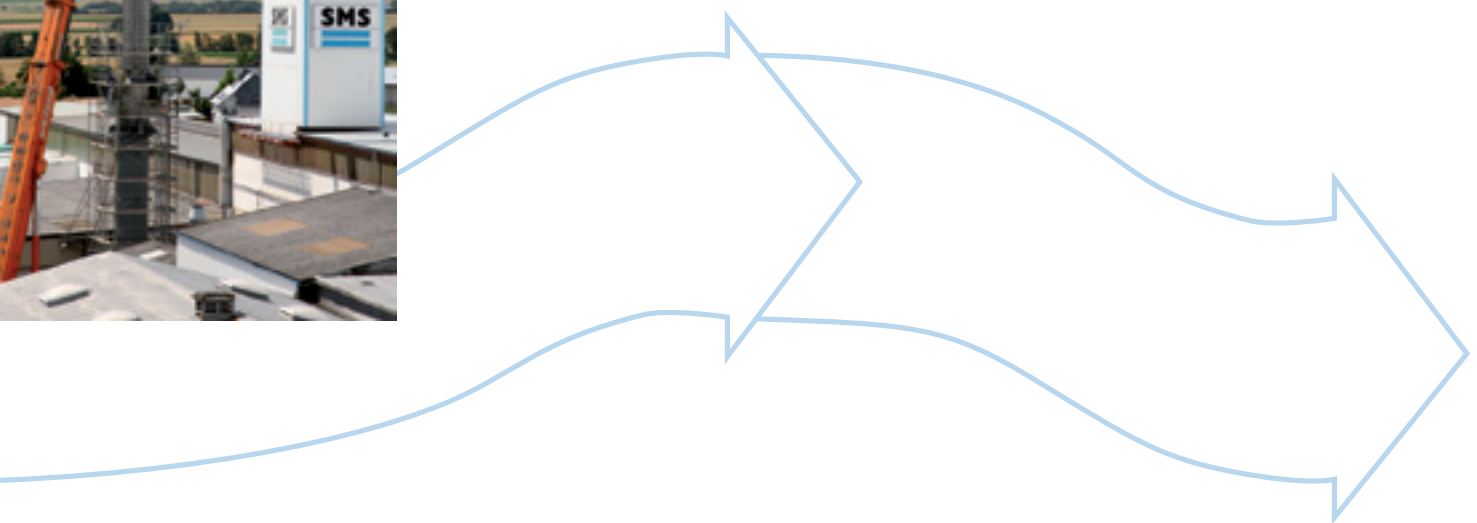



In detail our scope of services includes:

- Process know-how
- Test centre
- Rental pilot systems
- Joint process development with customers
- Basic and detail engineering
- Instrumentation and control system design
- Piping /plant design engineering
- Project management
- Mechanical design
- Fabrication
- Special equipment manufacturing
- Assembly supervision
- Start-up support
- After sales service



Equipped for any task

Our evaporation technology

4



As a technology leader and manufacturer in the thin film evaporation business, Buss-SMS-Canzler has the broadest manufacturing program worldwide.

We offer our clients exclusive cost-effective process solutions that ensure the highest product qualities. Taking your specific process requirements into consideration, we plan and build plants with one or more stages in various configurations: thin film evaporators, short path evaporators and complex column systems.

We always comply with the specific customer requirements and conform to all major international standards and codes.

For demanding tasks

We offer evaporators with different rotor types - horizontal, vertical, cylindrical or conical, in counter or co-current design. Our plants and machines meet the challenging demands of distillation, concentration, drying and reactions. The largest short path evaporator plant in the world, situated in South-East Asia, is equipped with seven Buss-SMS-Canzler evaporators.

Our new horizontal thin film evaporator, HYVAP DZH, is specially tailored for the pharmaceutical, cosmetics and food industries, meeting the increasing demands for continuous and gentle concentration of heat-sensitive, viscous and fouling products. Its hygienic design complies with all GMP-requirements.

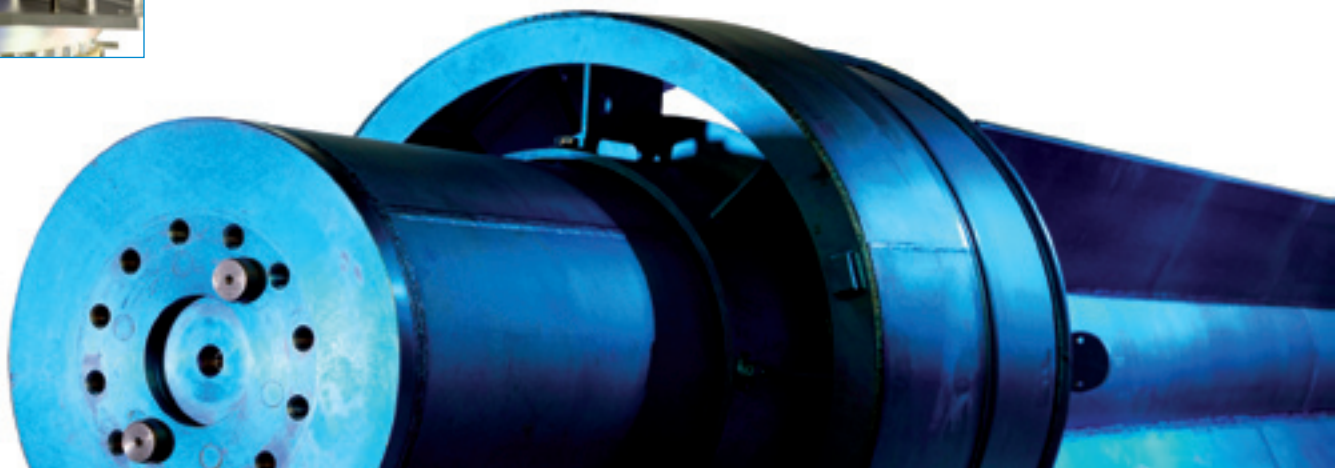



Buss-SMS-Canzler evaporation technology is applied worldwide in the following industries:

- Organic and inorganic chemistry
- Polymer and petrochemistry
- Oleo chemistry
- Pharmaceutical industry
- Food industry
- Environmental technology

As individual as your products

Drying technology

6



Dryers made by Buss-SMS-Canzler are always tailored to the characteristics of your product and its drying properties.

Advantages in service

Our vertical and horizontal thin film dryers are suitable in particular for temperature-sensitive materials due to the short residence time, and are often used for the treatment of solutions, suspensions, pastes and filter cakes.

Our segmented disc dryer ROVACTOR[®] facilitates the efficient drying of filter cakes, powders and granulates.

Multi-functional

Our all-purpose segmented disc processor REACTOTHERM[®], with an intensive mix and kneading effect and widely self-cleaning properties, can be used for the processing of pasty, viscous, fouling and lump-forming products. The REACTOTHERM[®] may also be used as a batch processor.



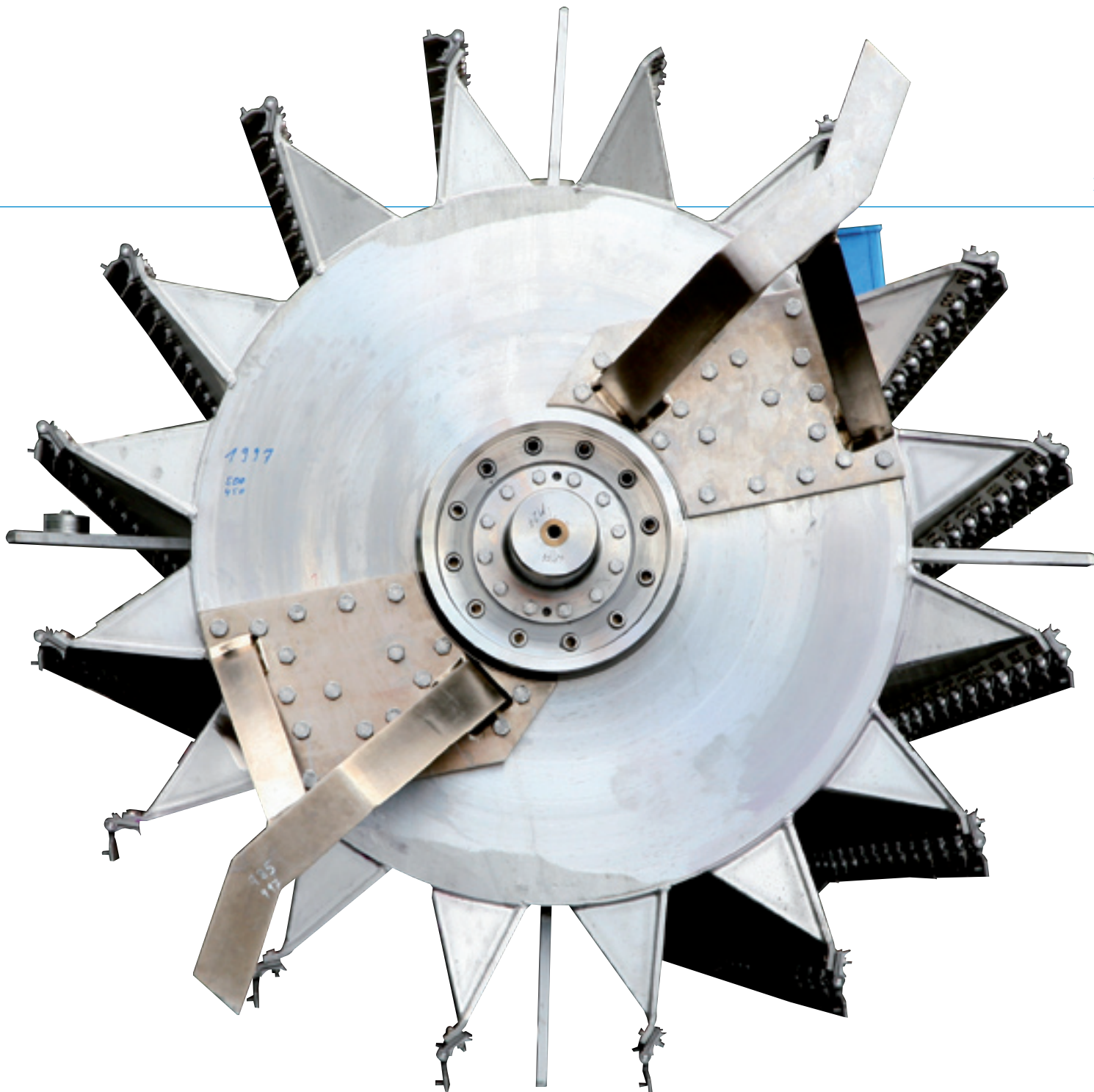

For special requirements

For manufacturing processes with special hygienic requirements – primarily for use in the pharmaceutical and food industries - we have developed the CONTIVAC NDP Processor, in accordance with the respective GMP requirements. It allows mixing, reactions, flashing and drying of different material flows all in one single contained processor.



Economical and flexible High-viscosity technology from Buss-SMS-Canzler

8



Buss-SMS-Canzler provides you with thin film processors and large volume reactors for your highly-viscous products.

Processors developed by us are suitable especially for thermal processes in the production of polymers and their post reaction treatment.

Thin film processors

The rotors of our Filmtruder[®] und Viscon[®] processors create thin product films with unmatched surface renewal and thus ideal conditions for the separation of large quantities of volatile materials from highly-viscous products.

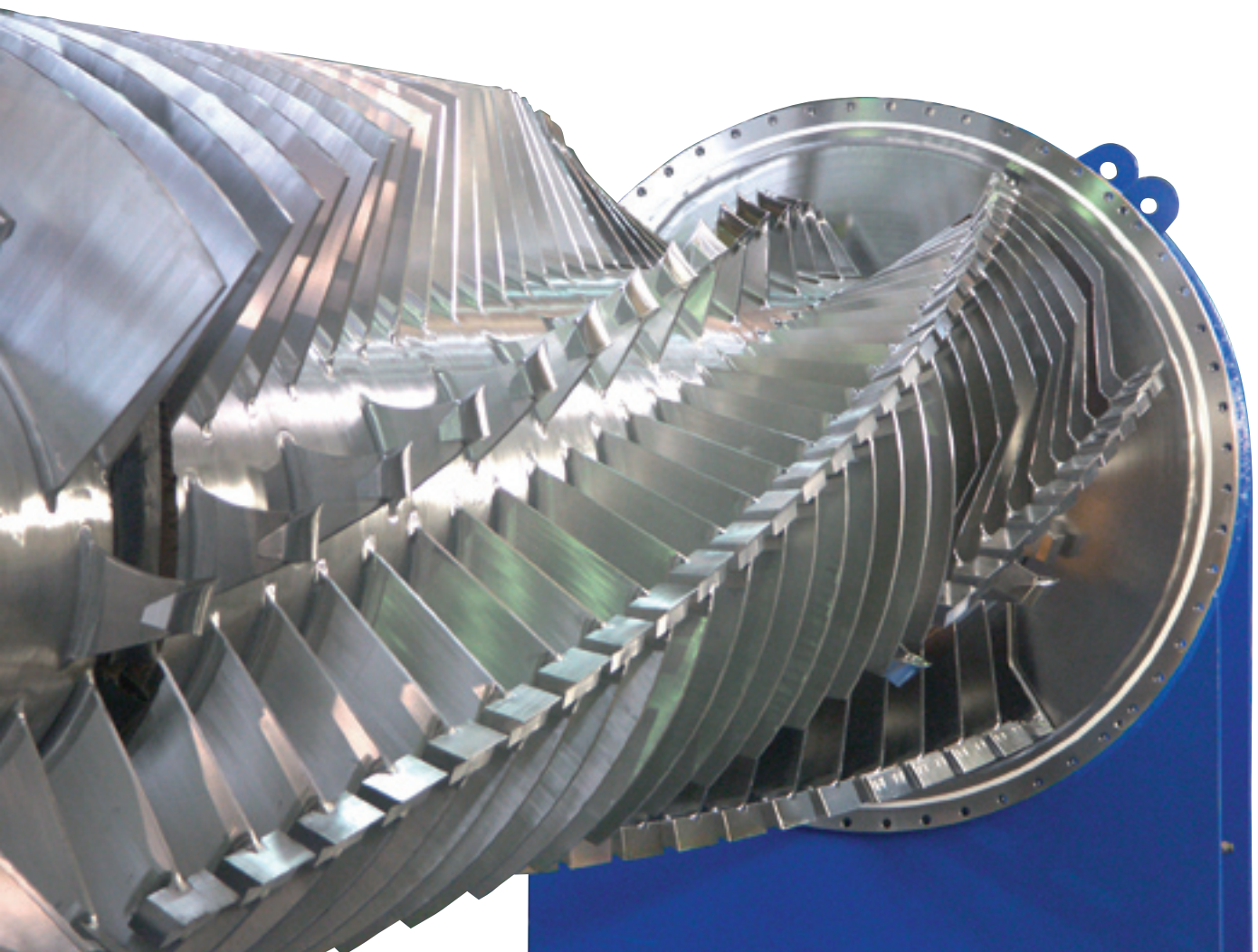

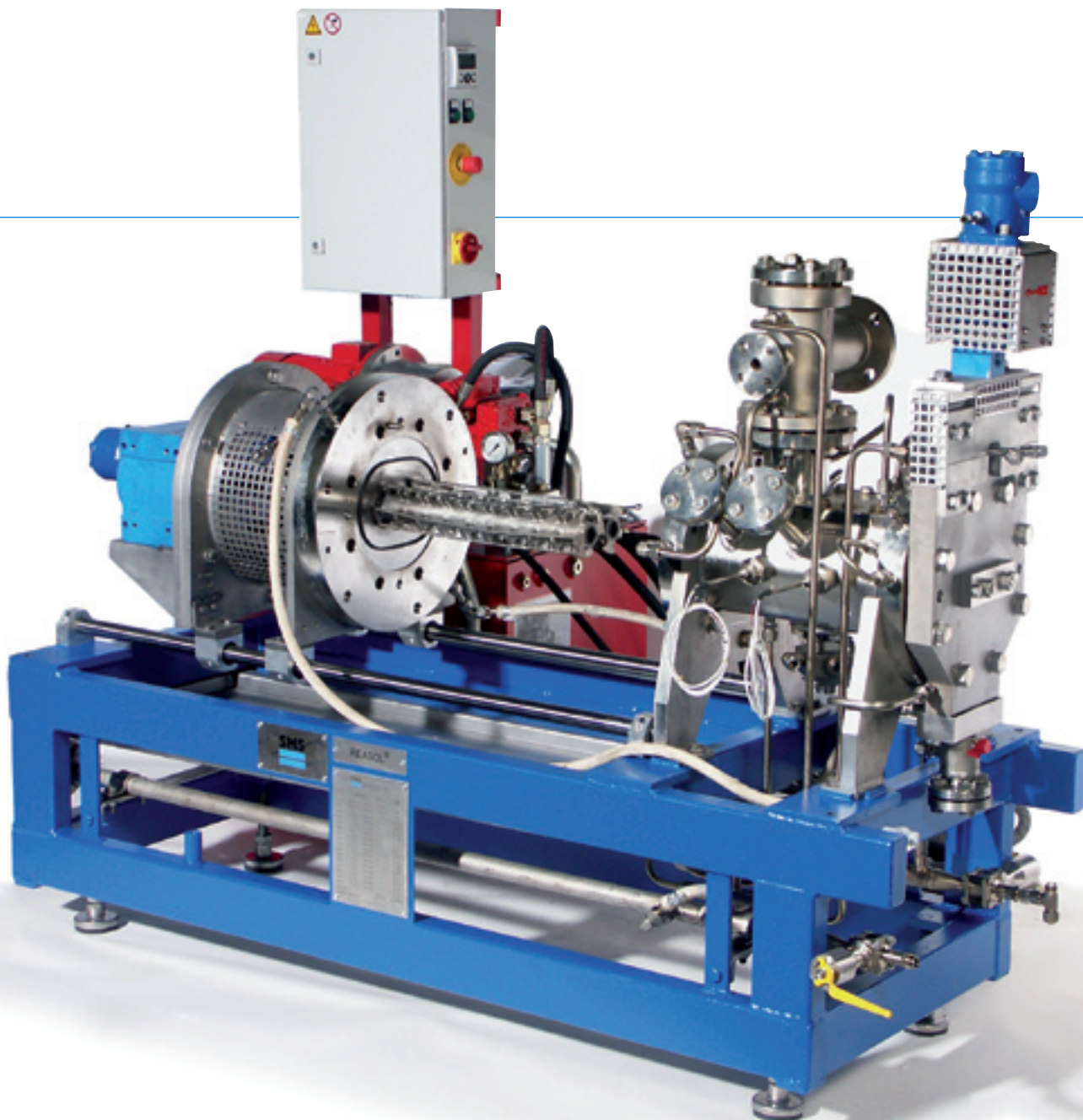

Large volume reactors

Our multi-functional REASOL[®], REACTOTHERM[®] as well as REACOM[™] and REAVISC[™] processor types are characterised by their very large processing volume and ensure the efficient handling of products with difficult processing characteristics or phase changes and allow long residence times. Mixing, devolatilization, reacting and phase changes can be performed in one single processor. A pilot reactor type REASOL[®] is shown above.

Success-oriented cooperation

We offer a special comprehensive service for the joint development of complex, customized plants and customer-specific systems utilising all our resources. This includes rental of pilot plants, tests in our testing facility, process engineering and design. The aim of this success-oriented cooperation is always the cost effective production of high quality products. Based on customer specific requirements we also combine our products with other standard technologies such as flash-evaporation and vented extruders.

Dehydration – the cost effective way Our membrane technology

10



Cost-effective with gentle product treatment and environmentally safe, that is our membrane technology.

The membrane technology of Buss-SMS-Canzler with vapour permeation and pervaporation proves its value particularly in the dehydration of ethanol and other alcohols as well as various solvents – beyond the azeotropic point.

Our membranes in ethanol dehydration service reduce a water content of max. 20% to values under 0.1% in one single step. The relief of the distillation column and the effective heat recovery allow considerable energy savings. No chemicals or additional agents are required.

The membranes have no moving parts and negligible maintenance costs.

In summary: we reduce your production costs and provide high quality solvents.

Our experience for your benefit The test centre

11

From feasibility studies for new production processes to the design of new plants and basic trials for scale-ups or process optimization.

Trials are the safest way to make correct investment choices. With this in mind, we present you our test centre in Pratteln (Switzerland) with its 20 pilot plants for evaporation, high-viscosity and drying technology. Simultaneously we use a chemical and physical laboratory to analyse product samples. So we are able to test your products – even flammable, explosive and toxic substances. With customized test plants and equipment we realize your special process solution.

Prompt realization due to close integration and interaction

The comprehensively equipped test centre enables us to modify process conditions. When the main plant parameters are established, process and plant engineering can start – always in the responsibility of the same project manager. Such close integration considerably shortens the time demand for development, planning and realization of a plant.

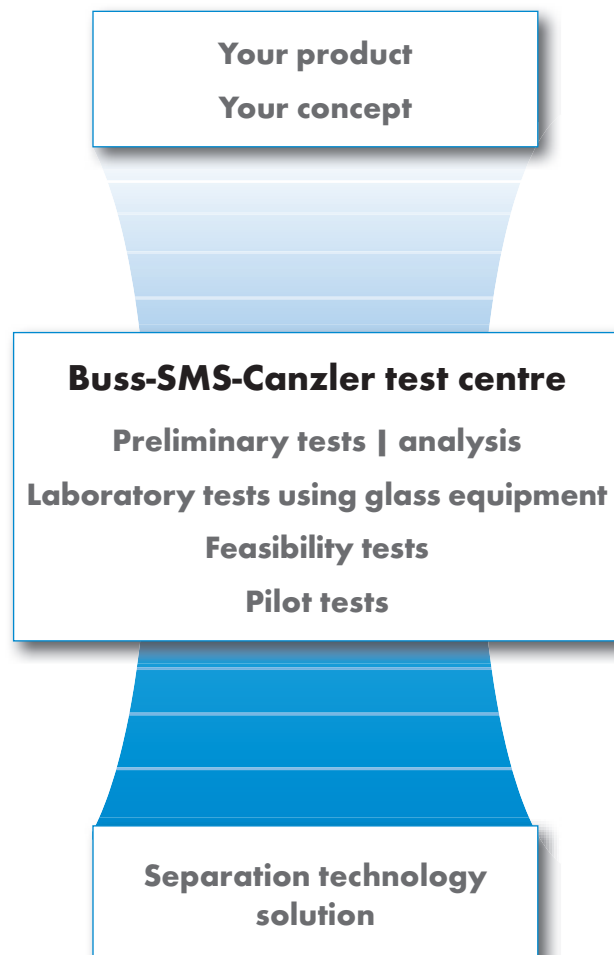

Always precise and on schedule Our manufacturing

12



All key components of our technologies are manufactured in our workshop in Butzbach.

The basis for the quality of our products lies in our experienced experts, proven manufacturing procedures, as well as modern machining and welding equipment. Our flexible production capacity and audited sub-contractors ensure production schedules are strictly adhered to.



Certified Quality

Our quality assurance system complies with the requirements of:

- ISO 9001
- ASME U-Stamp
- China Boiler- and Pressure Vessel Regulations
- KTA 1401, AVS 0100/50
- Authorisation for Korea

We are certified according to all important international pressure vessel design codes.

In addition to all standard stainless steel materials we also fabricate out of special materials, such as titanium, nickel and nickel-based alloys.

Tailored to your requirements

Special equipment manufacturing

13

For demanding tasks in the best quality we deliver customised special equipment made out of solid, clad or lined material.

Our particular strength are copper-lined piping and reactors and copper or copper-alloy heat exchangers. The inhouse manufacture of this equipment is based on many years of know-how that dates back to the receipt of patents for copper welding.

Buss-SMS-Canzler also supplies evaporators and heat exchangers for various applications in the nuclear industry. For these special components we provide comprehensive test equipment and skilled personnel for all areas of project management and documentation. Moreover, our workshop also allows the manufacturing of large, heavy and demanding equipment in our workshop facilities.

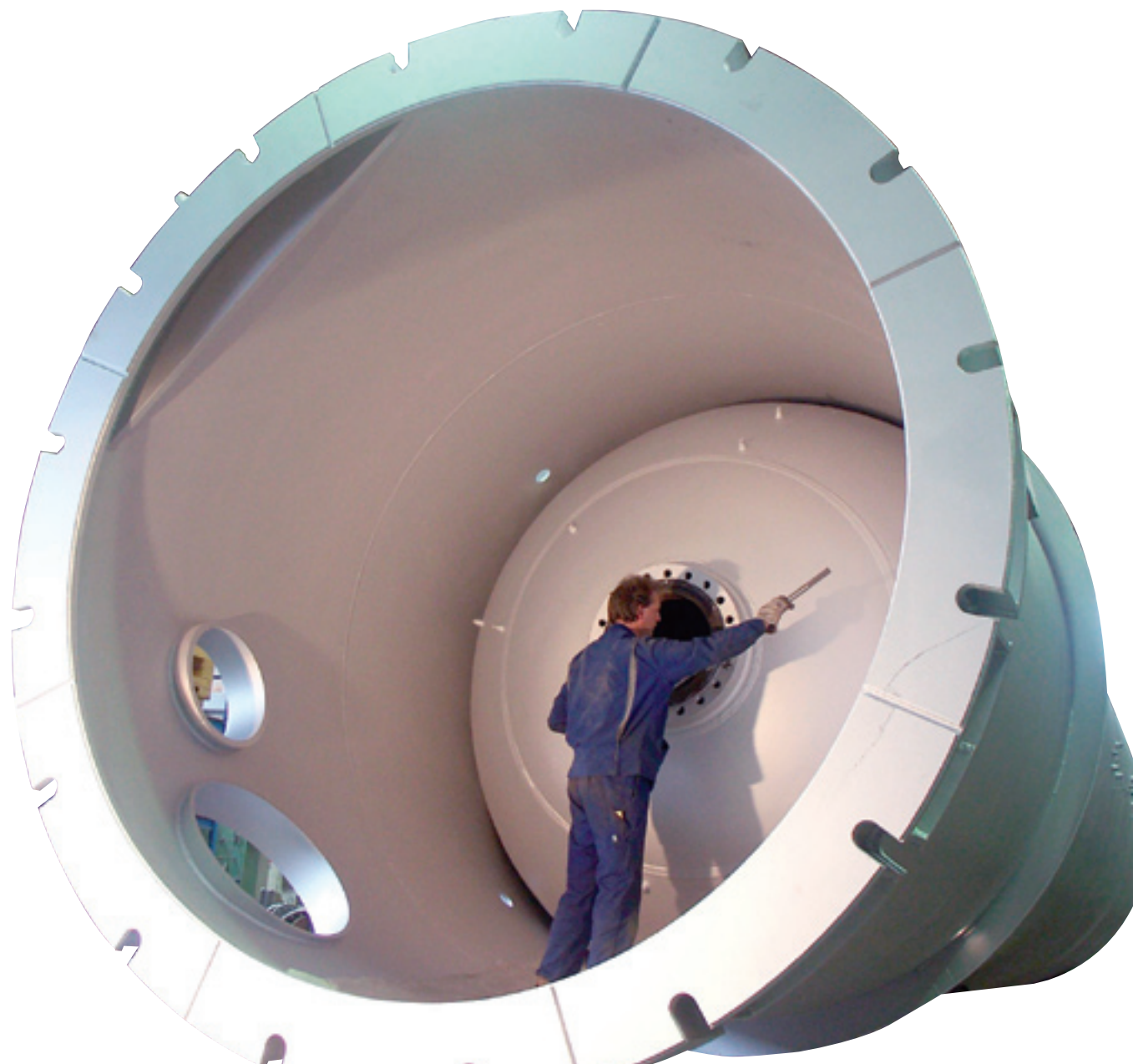

One source Professional project management by Buss-SMS-Canzler

14



The starting point of our services is the analysis of your individual requirements. Based on pilot tests and sample productions in our test centre we decide on the type of process and then proceed to the design phase.

Our dedicated project team advises and supports you throughout every phase - from the production idea to the optimized quality production. Our experts perform all the necessary steps, from plant layout with basic and detail engineering, design and construction of the equipment and assembly resp. assembly supervision up to the delivery to site, final inspection and start-up. In addition, the operating personnel can be trained on-site, if required. We also provide after-sales service contracts for the maintenance and repair of your plants and equipment.

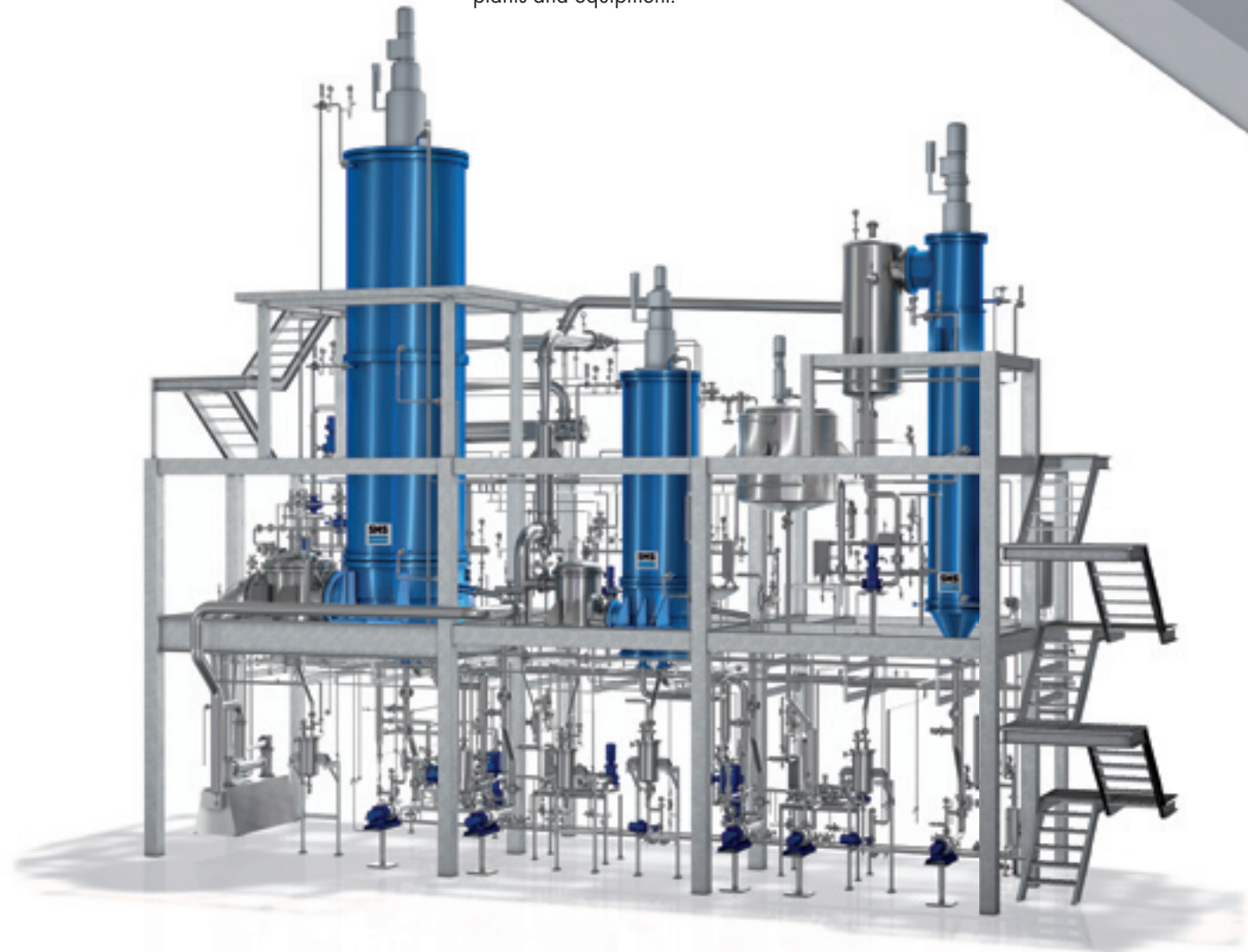
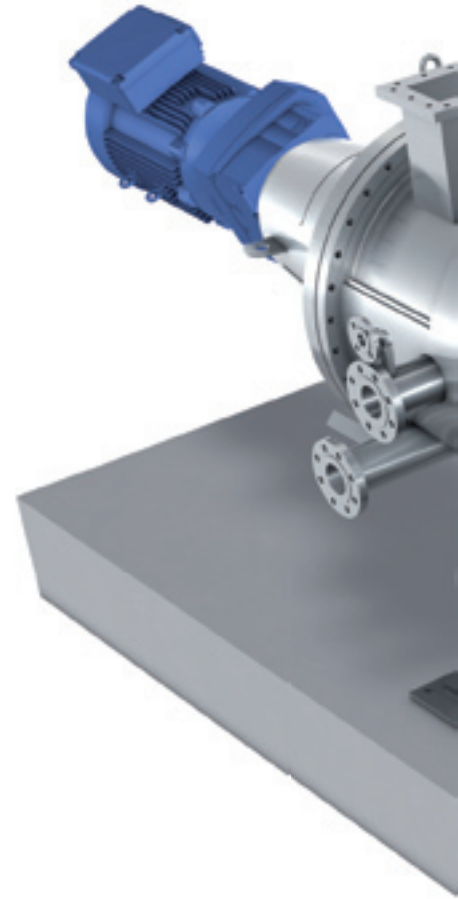

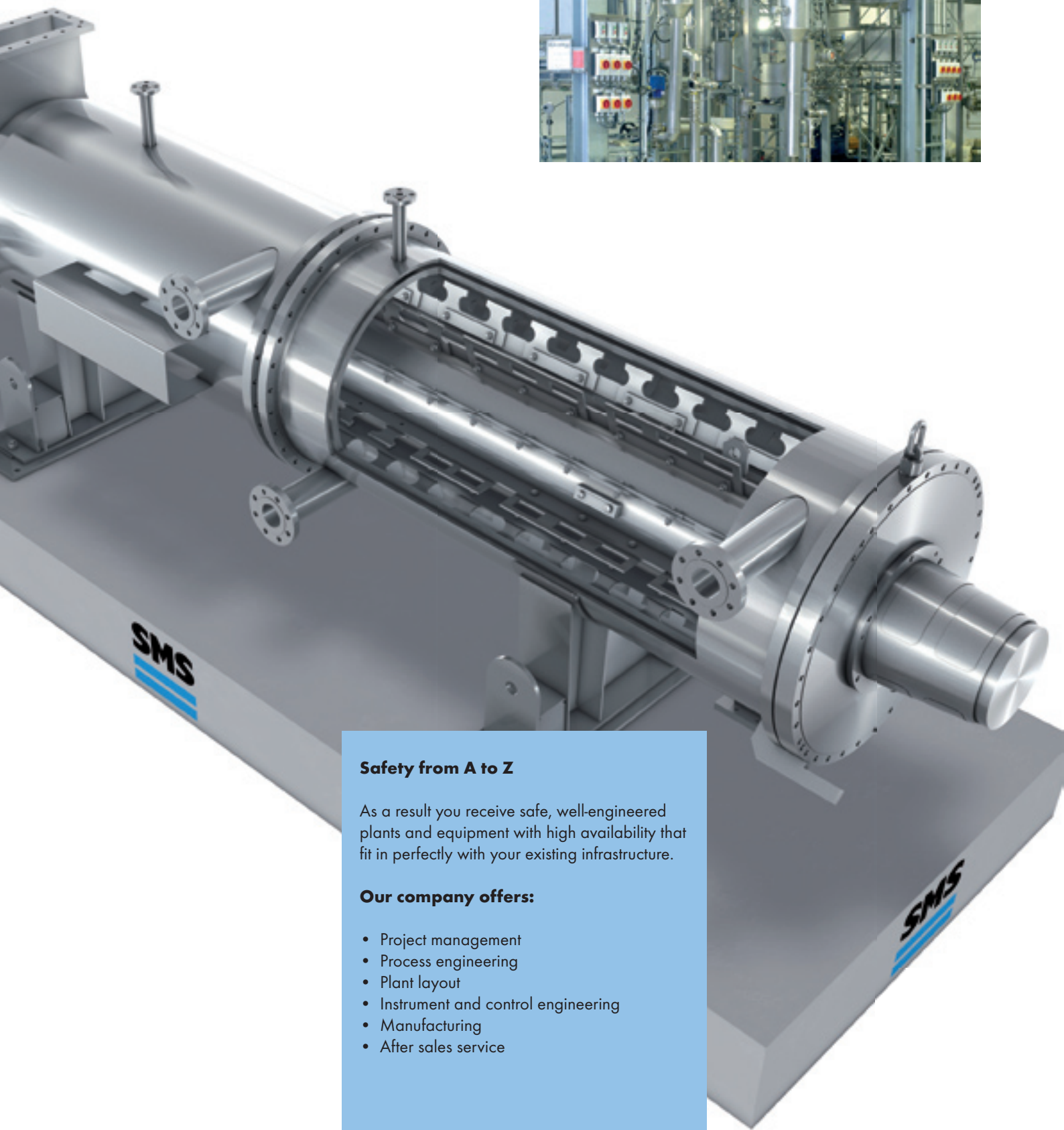

Safety from A to Z

As a result you receive safe, well-engineered plants and equipment with high availability that fit in perfectly with your existing infrastructure.

Our company offers:

- Project management
- Process engineering
- Plant layout
- Instrument and control engineering
- Manufacturing
- After sales service

ООО «ТИ-СИСТЕМС» ИНЖИНИРИНГ И ПОСТАВКА ТЕХНОЛОГИЧЕСКОГО ОБОРУДОВАНИЯ

Интернет: www.tisys.ru www.tisys.kz www.tisys.by www.tesec.ru www.ти-системс.рф

Телефоны: +7 (495) 7774788, 7489626, 5007155, 54 Эл. почта: info@tisys.ru info@tisys.kz info@tisys.by

Available for you worldwide

Buss-SMS-Canzler operates globally and is present in all important markets. Competent local contacts guarantee the immediate handling of any query you may have and arrange rapid and professional advice.

Service you can count on

The provision of spare parts for the entire service life of our equipment is as self-evident to us as our commitment to automate, improve and re-build on demand all plants and equipment delivered by us. Customers all over the world reward this service-oriented attitude with a long-lasting collaboration.



SMS

We live process engineering
and special manufacturing

Buss-SMS-Canzler